



Ω

θ

θ



		μ				
		μ				
						μ
						Ω
						Ω
						Ω

		Ω				

			μ			

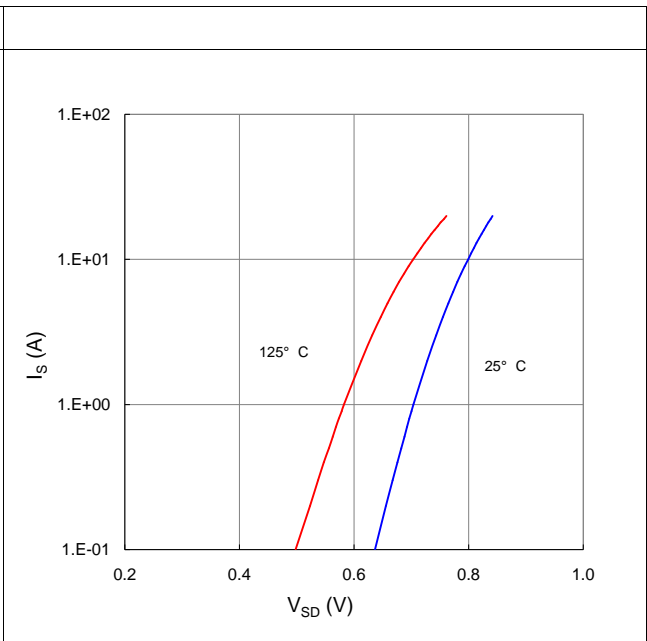
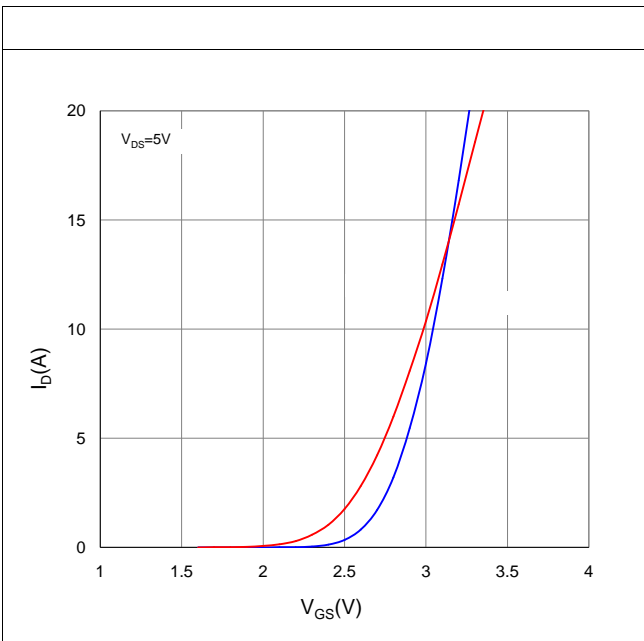
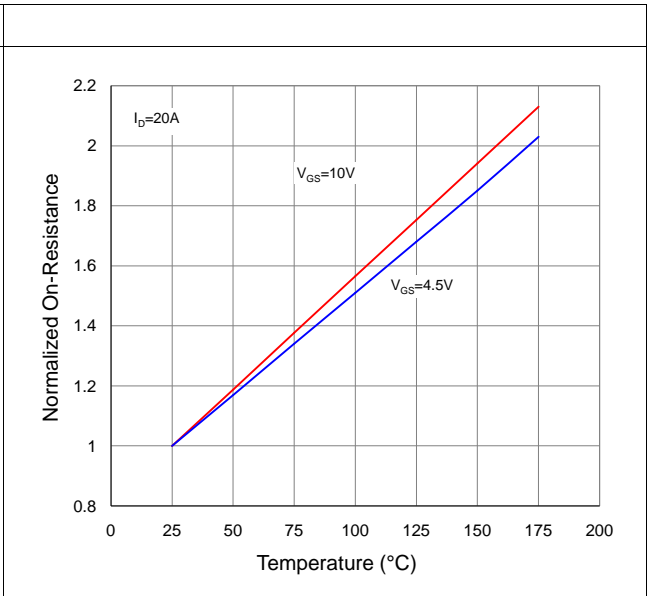
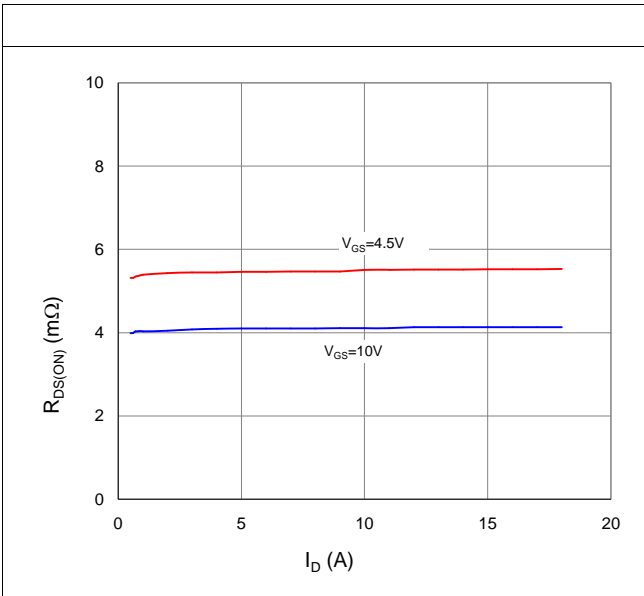
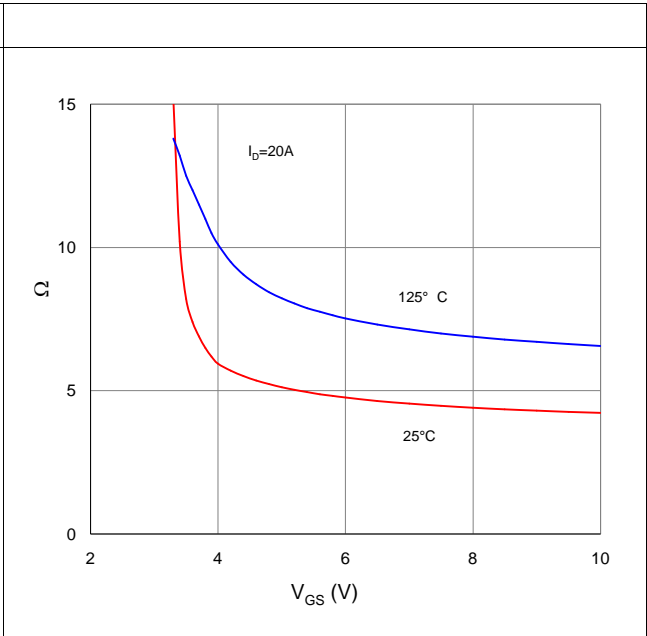
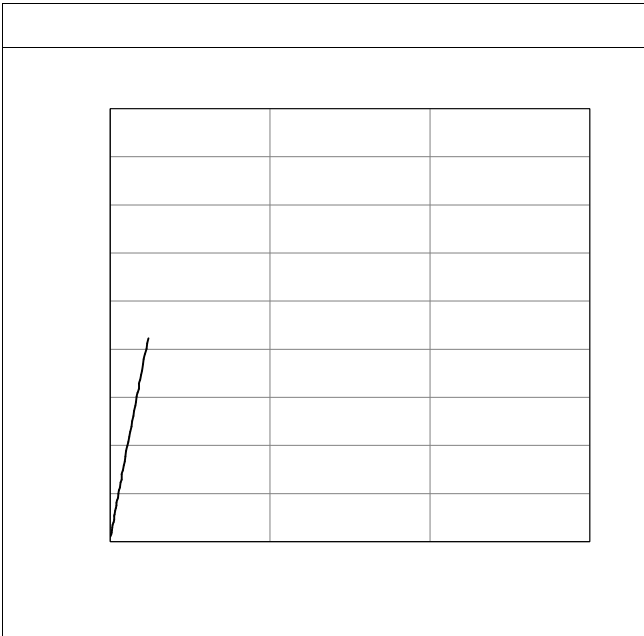

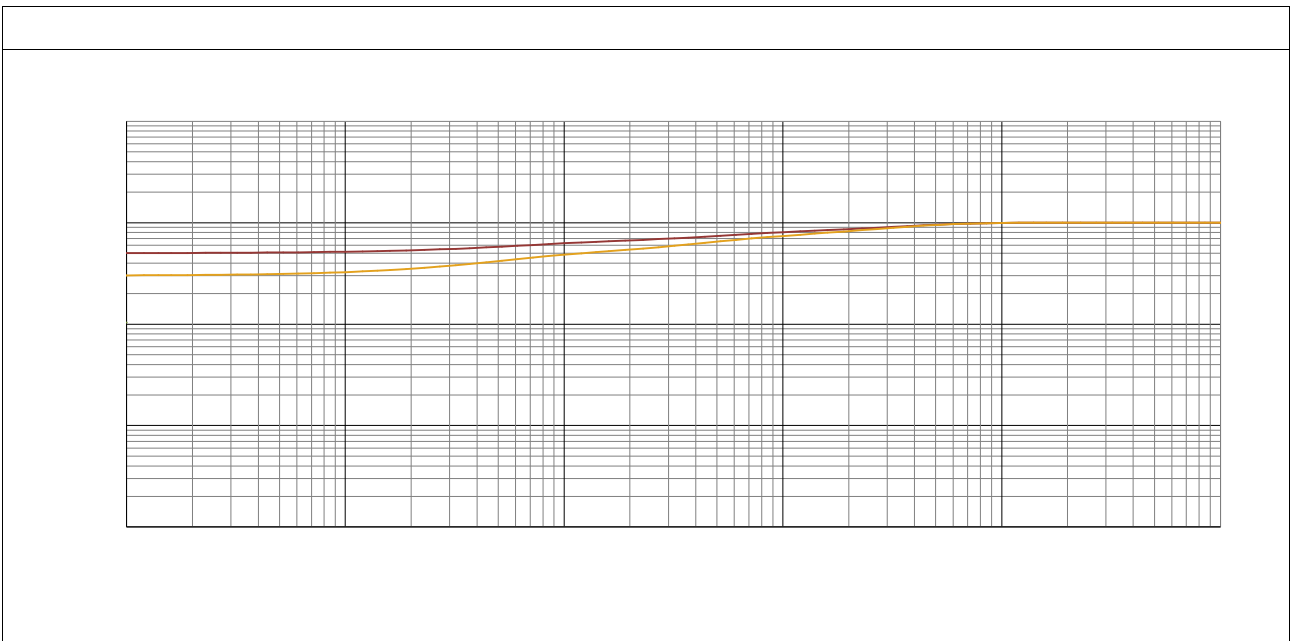
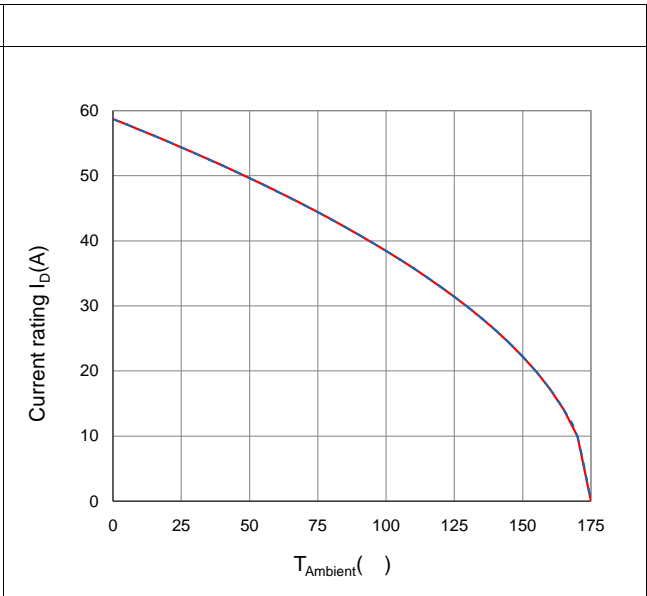
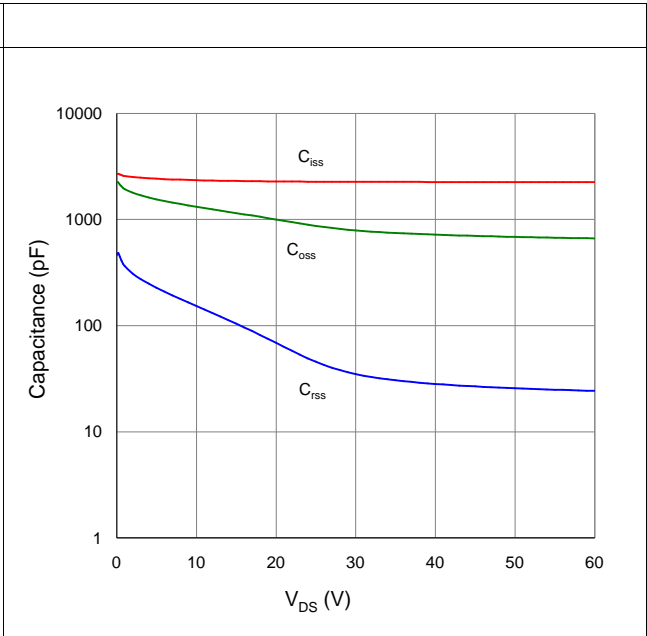
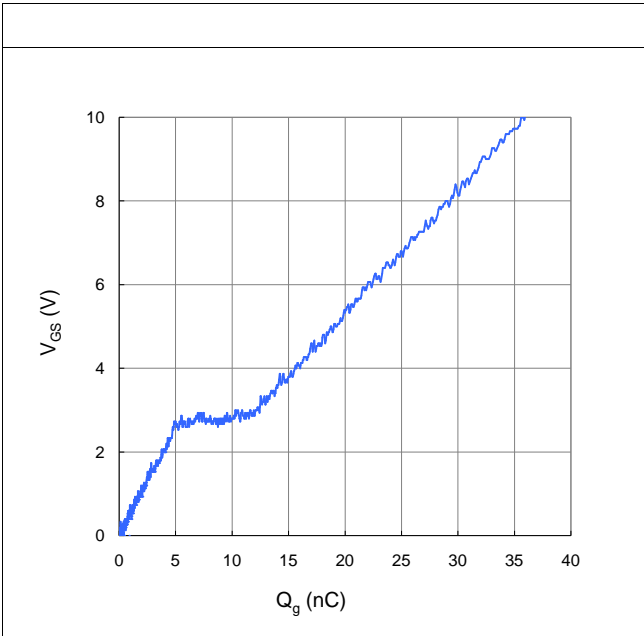



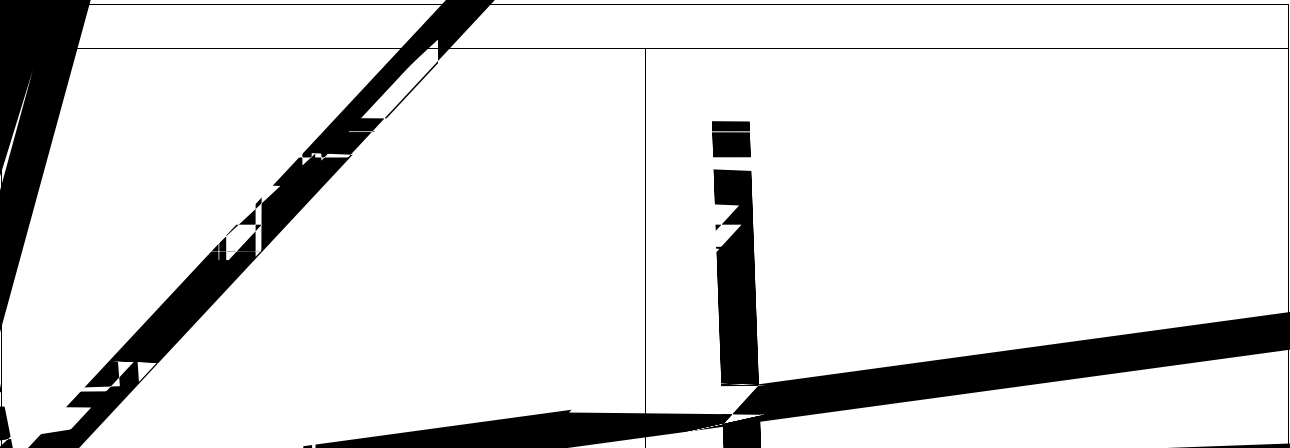
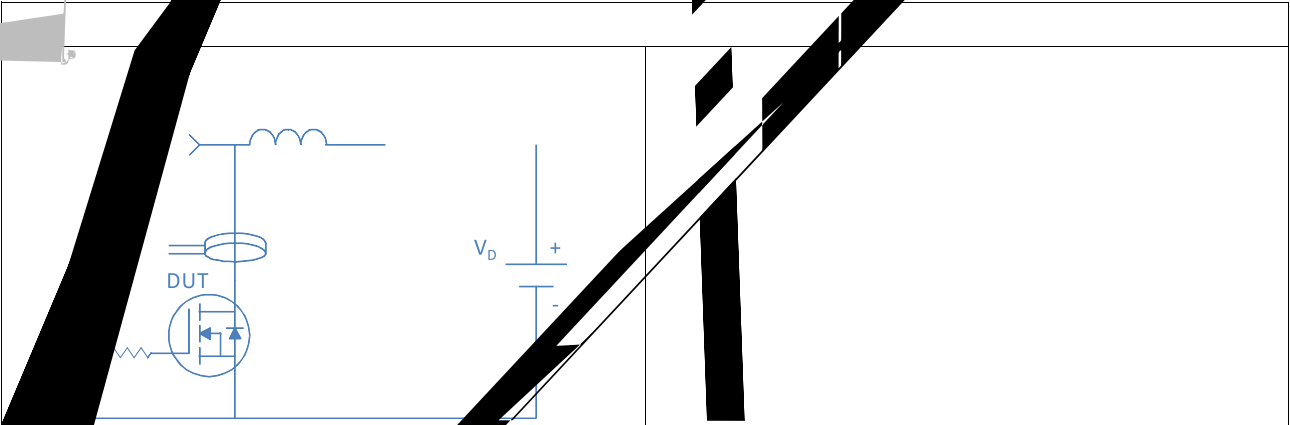
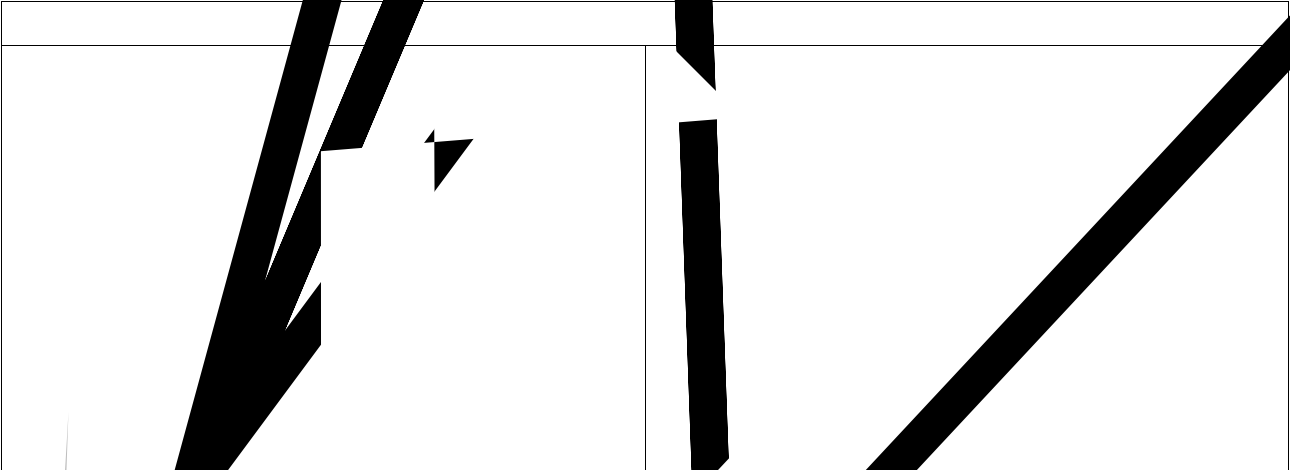
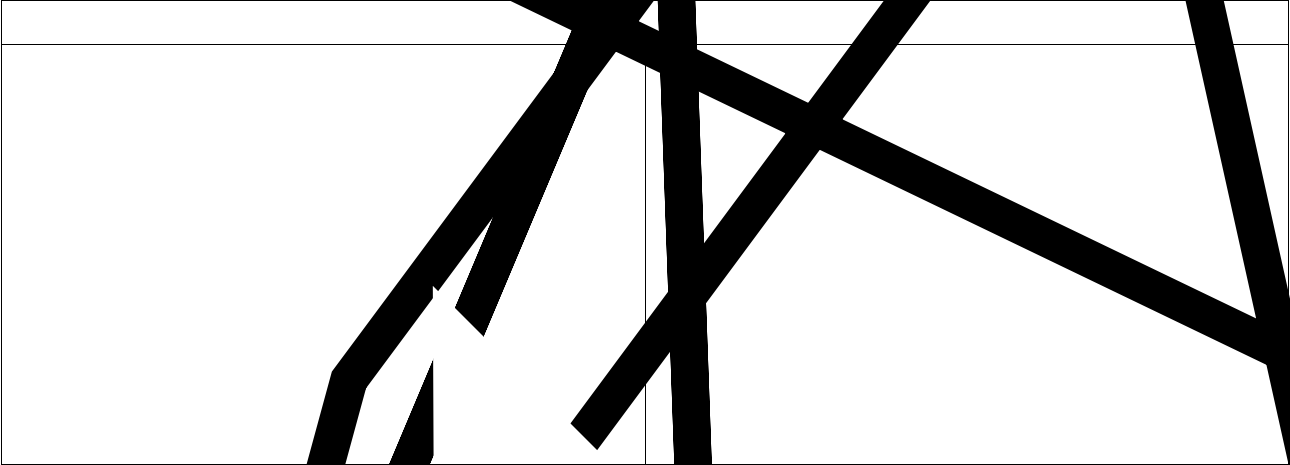

Hunteck

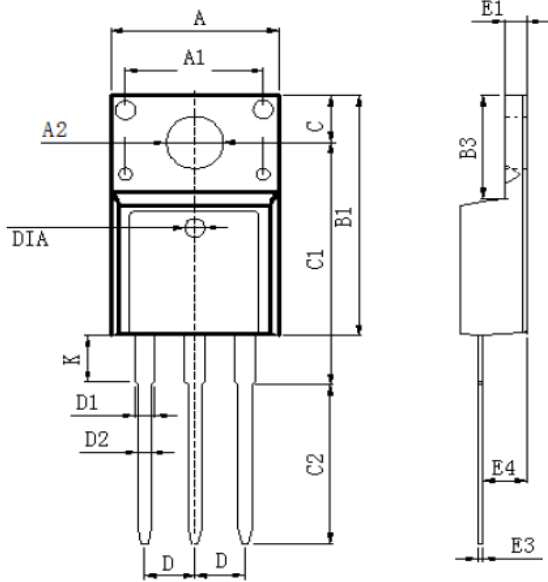



DIM	MILLIMETERS
A	10.16±0.3
A1	7.00±0.1
A2	3.3±0.2
A3	9.5±0.2
B1	15.87±0.3
B2	4.7±0.2
B3	6.68±0.4
C	3.3±0.2
C1	12.57±0.3
C2	10.02±0.5
D	2.54±0.05
D1	1.28±0.2
D2	0.8±0.1
K	3.1±0.3
E1	7.54±0.1
E2	5.1±0.1
E3	0.5±0.1
E4	7.1±0.1
E5	0.5±0.1

1.5 (deep 0.2)

DIA 
Unit: mm